

50 Years Innovation 1975-2025



& **POOLlock**



Proteam Europa & Poollock

CATALOGUE



Sakrisoy Lofoten Norway

PROTEAM Europa & PoolLock history



Proteam Europa & PoolLock

Started in Norway in 1972



The company was founded by Siv. Ing. Harald Einevoll in the mountains of Norway.

1968: Harald earned his first university degree in Electronics.

1972: He completed his second university degree in Physics and was employed by the U.S. Air Force to develop seismic systems for detecting nuclear explosions. As a hobby, he established a development center for energy-saving technologies in an old wooden shoe factory.

1975: 50 years ago, Harald installed the first PoolLock Safety Cover and a multifunctional Proteam Heat Pump, resulting in energy savings of 85%.

1985: Harald developed the "Proteam Ammoniac Remover," which was copied by a Danish company within 2-3 years.

1992: He modified the PoolLock Safety Cover, creating the PoolLock V4, which remains a bestseller 32 years later. Unfortunately, PoolLock V4 has been illegally copied by a few companies.

2001: Harald introduced Proteam Heat Pumps with a high Coefficient of Performance (COP). This was the first heat pump to achieve a real COP higher than 6 W/W.

2017: Harald launched a major project called "Health Station1" (HS1), which provides free information on health, wellness, food, and wine.

2019: Proteam Silent Heat Pumps for swimming pools were introduced.

2022: Harald began a new project, developing a lightweight insulated moving pool terrace.

2024: Harald was granted a patent for his innovative moving pool terrace.

Harald continues to work full-time for Proteam & PoolLock. If you have any ideas, he'd love to hear from you!

Email: harald@einevoll.no - Mob UK: +44 79 1776 8585 or

Mob Norway: +47 90 55 99 55

1985



2024



Maidenhead, UK



Thessaloniki, Greece



+44 1293 77 44 14 / 33
www.poollockuk.com
factory@poollockuk.com

+30 2310 462 122
www.poollockgr.com
factory@poollockgr.com

Proteam and PoolLock products



Proteam Europa & PoolLock

Page 4

Movable Pool Terrace - Patented
Max size 12m x 30m - 300 kg / m²



PoolLock Safety covers

Page 8

Max size 12m x 25m
New version - V4S



PoolDeck Slatted Cover

Page 24

Installations: Top / Bottom pit & Wet / Cave pit

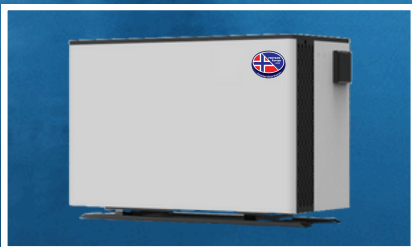

Proteam Swimming Pool Heat Pumps - Silent

Page 24

New version - PS
Easy maintenance

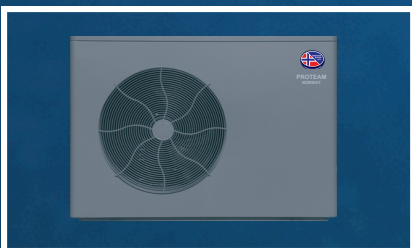

Proteam House Heat Pumps

Page 24

Heat and Cool



Proteam - Silent Fan coils

Page 24

Heat and Cool

50 Years Innovation 1975-2025



&



Proteam Europa & PoolLock

PROTEAM Moving Pool-Terrace

Convert your Pool to Terrace or your Terrace to Pool - in just 20 seconds

Patented Movable Pool-Terrace – Your new versatile terrace solution.
Experience the ultimate convenience for your pool

- Maximum energy savings
- Elegant aesthetics
- Enhanced safety
- Reduced cleaning requirements
- Minimized chemical usage
- 10-year guarantee for peace of mind



Specification Pool-Terrace

- Up to 12 m Track to Track (TT)
- Up to 50 m Track Length (TL)
- Height from Ground 180 mm (plus Decking)
- Up to 300 kg / m²
- Up to 1500 kg / 10 m² (15 adults)
- Up to 5000 kg / 50 m² (50 adults)
- The best existing Energy Saver for Pools
- Energy Loss: 0.25 W / m² / °C (Insulated)
- Energy Loss: 1.10 W / m² / °C (Not Insulated)



50 Years Innovation 1975-2025



&



Proteam Europa & PoolLock

PROTEAM Moving Pool-Terrace

Convert your Pool to Terrace or your Terrace to Pool - in just 20 seconds

Proteam Pool-Terrace is prepared for different decking
Wood Decking - Artificial Wood Decking - Tiling - ABS



Proteam Pool-Terrace

Effortless Assembly: Comes with a straightforward installation manual. No special tools required!

Expert Assistance: A factory engineer is available to help you with assembly.

Affordable Shipping: Max package length of 5.9m for easy transport.

Join Our Dealer Network: Become a loyal dealer and receive maximum discounts.

Special Anniversary Offer: Enjoy an extra 25% discount during our 50 years anniversary (2025)

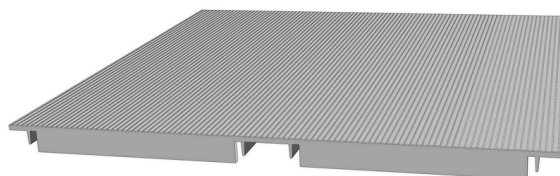
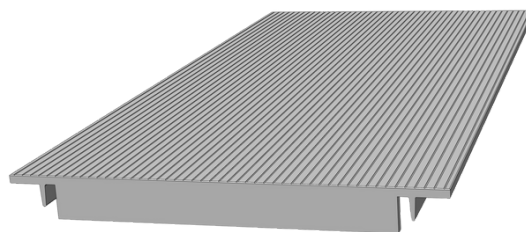

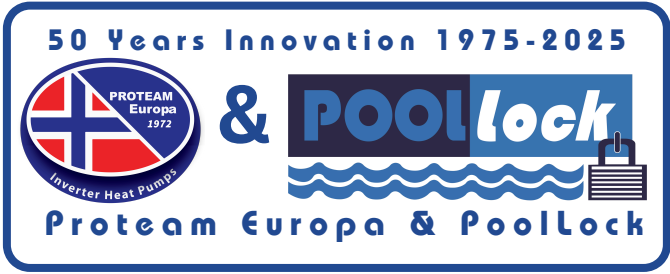

PROTEAM

Moving Pool-Terrace

Assembling

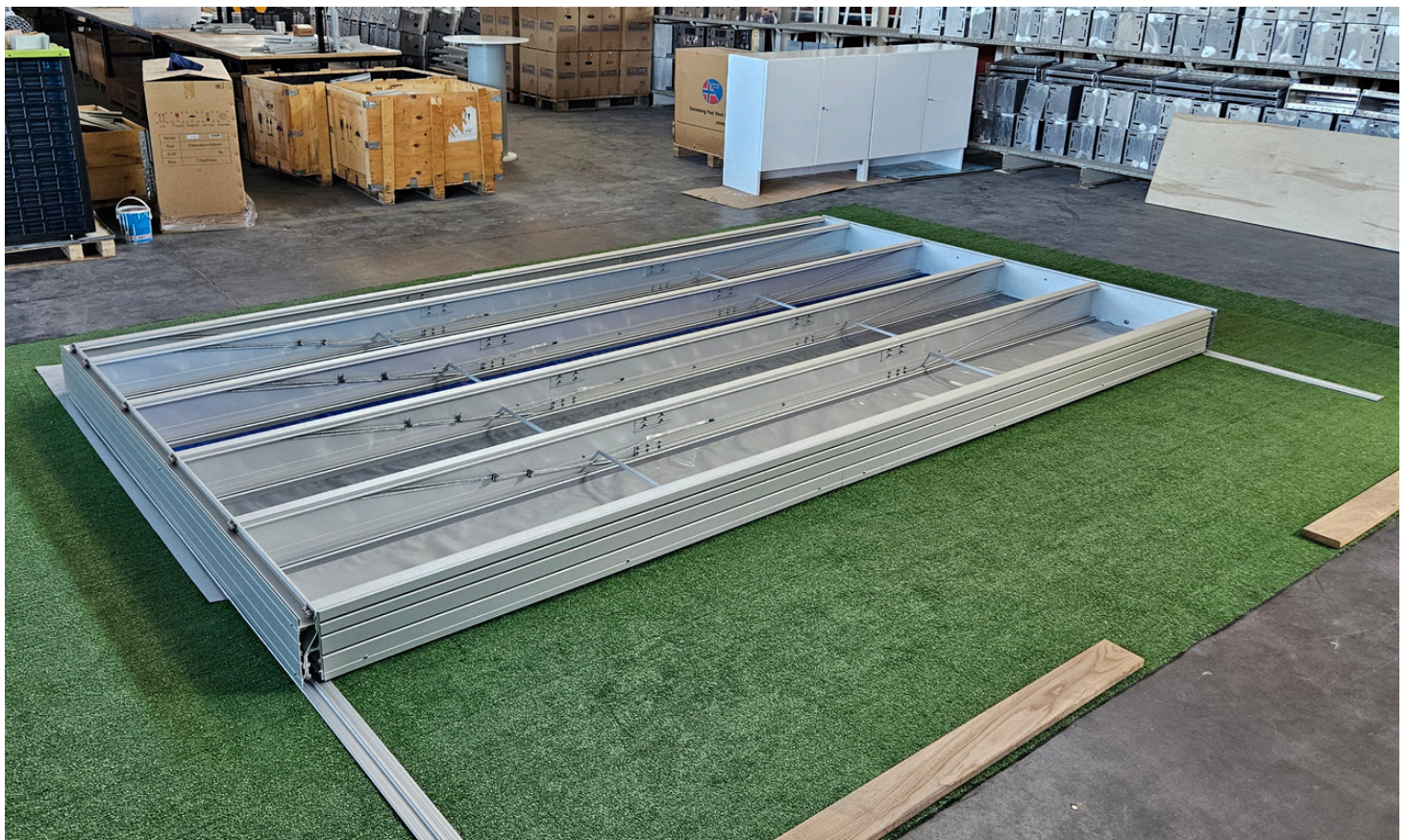
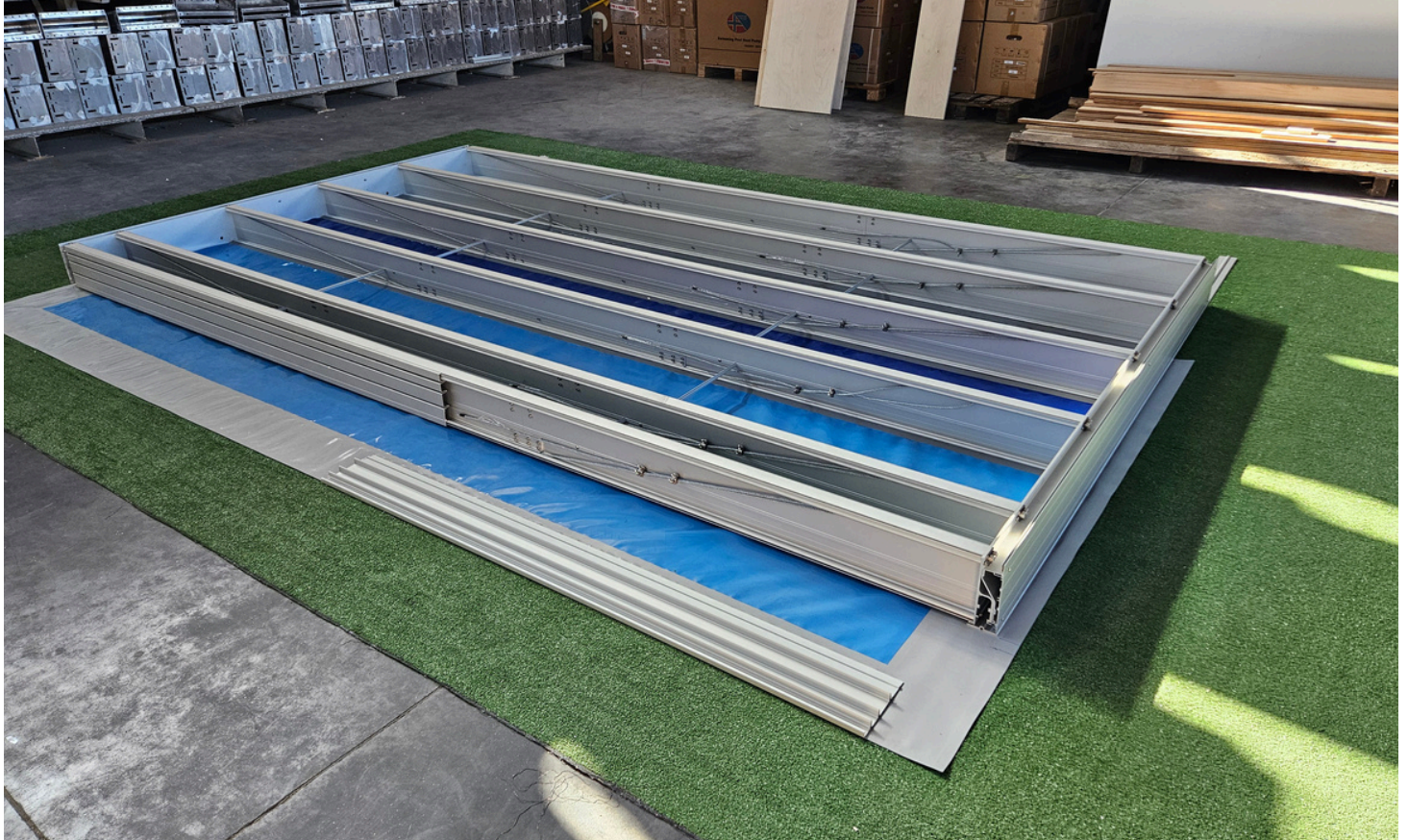

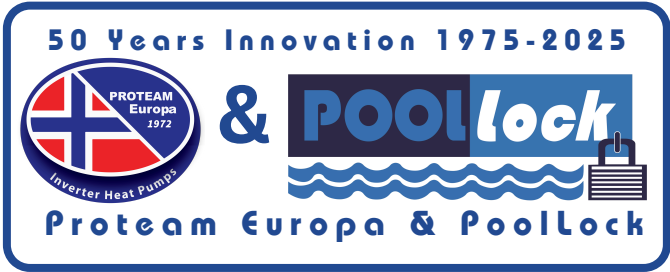

PROTEAM Moving Pool-Terrace First Testing

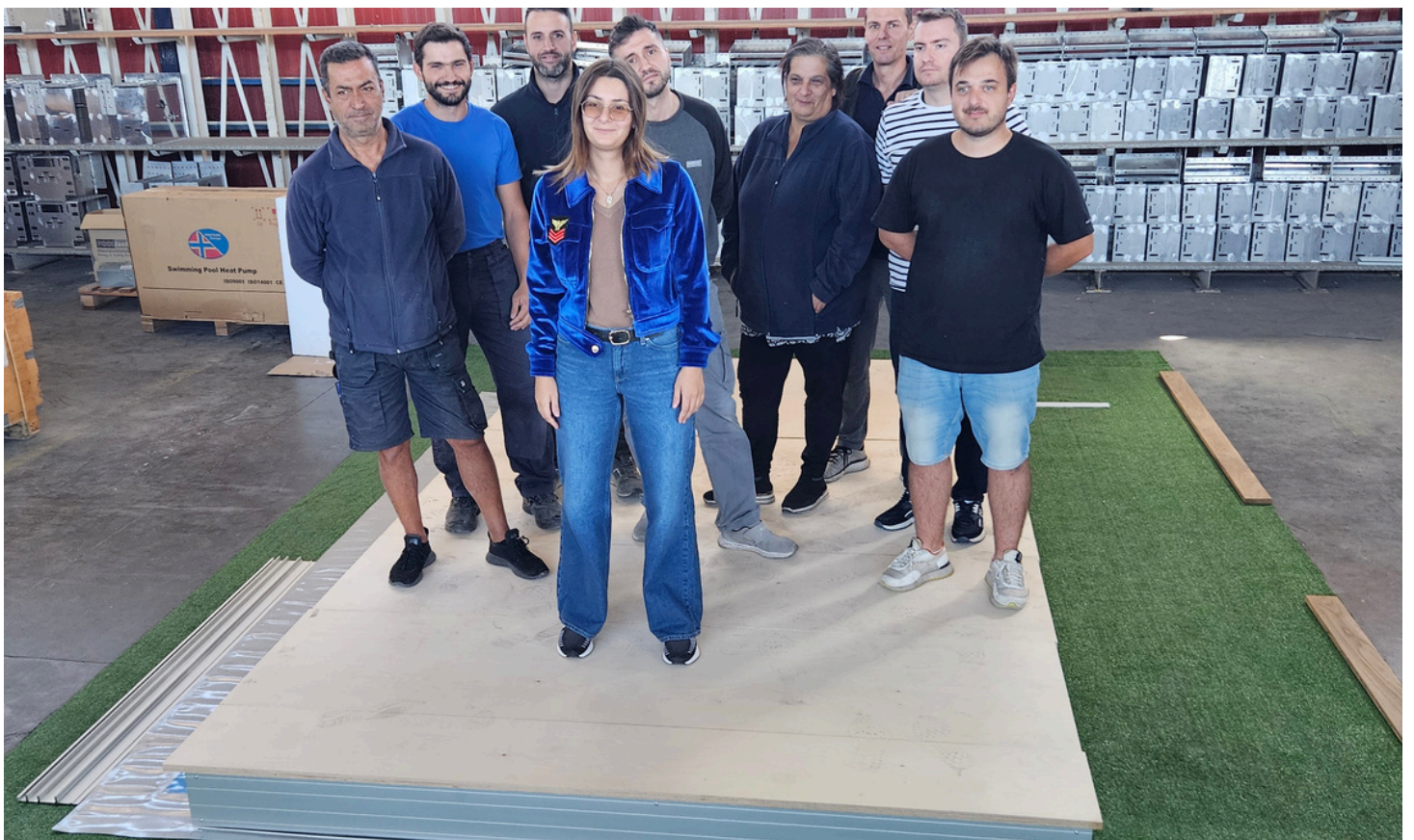
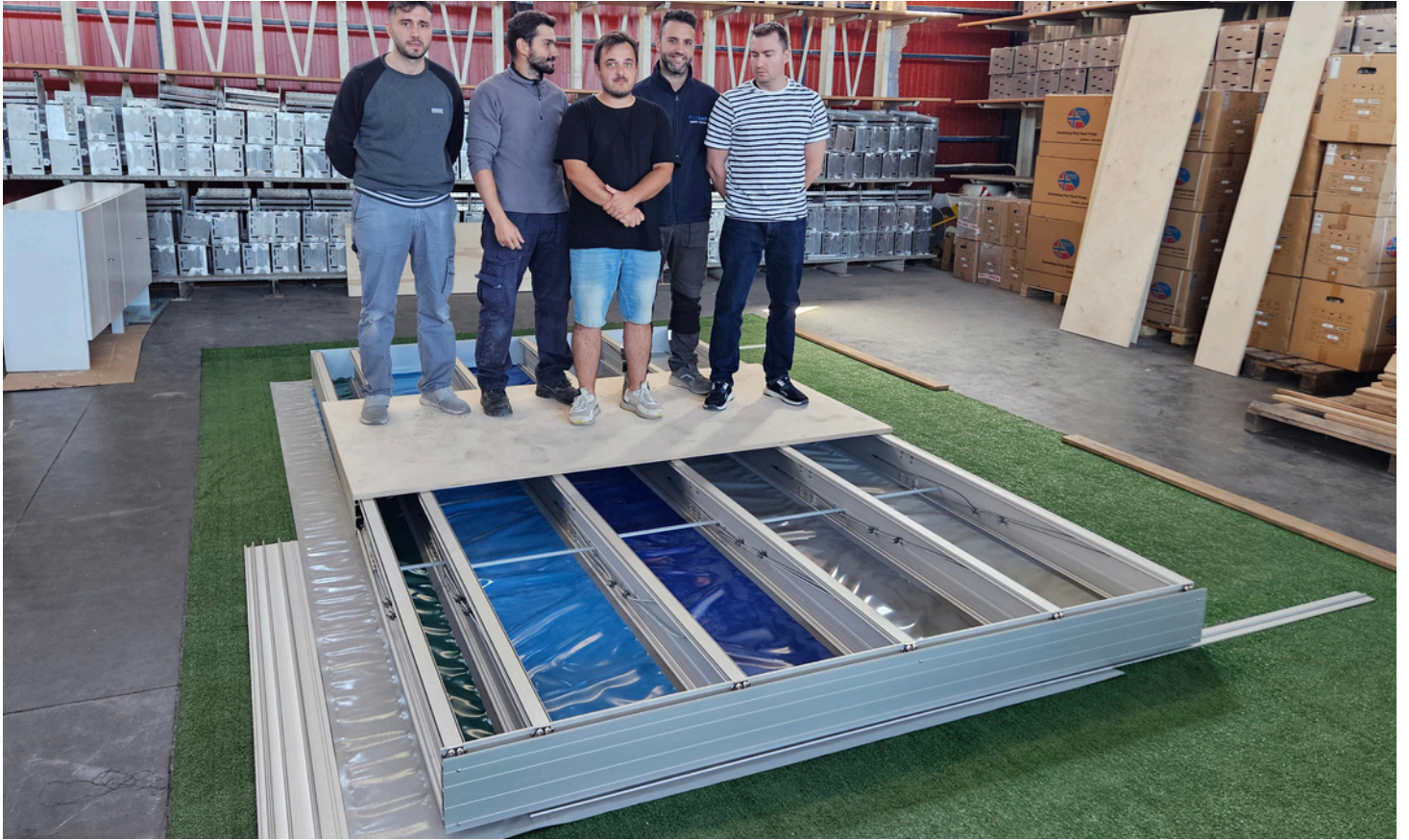



PoolLock Automatic Safety Covers



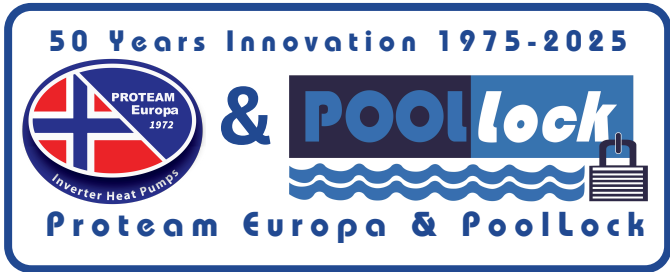

PoolLock Automatic Safety Covers



Your pet's safety matters too. PoolLock Automatic Safety Covers are specifically designed to keep your furry friends safe, preventing them from accidentally wandering into the pool. With PoolLock, you can have peace of mind knowing your pets are protected, even when you're not there to supervise.



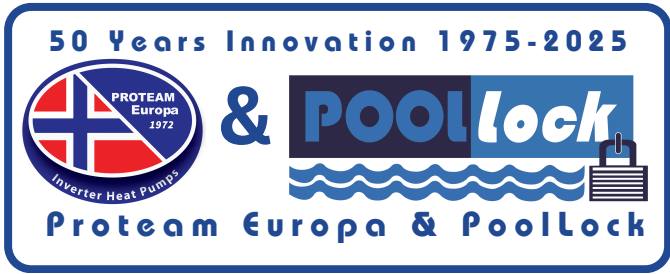

PoolLock Automatic Safety Covers



Turn the switch and reveal the crystal clear water.



Close in 30 sec



Open in 30 sec



Open - Everything is totally hidden

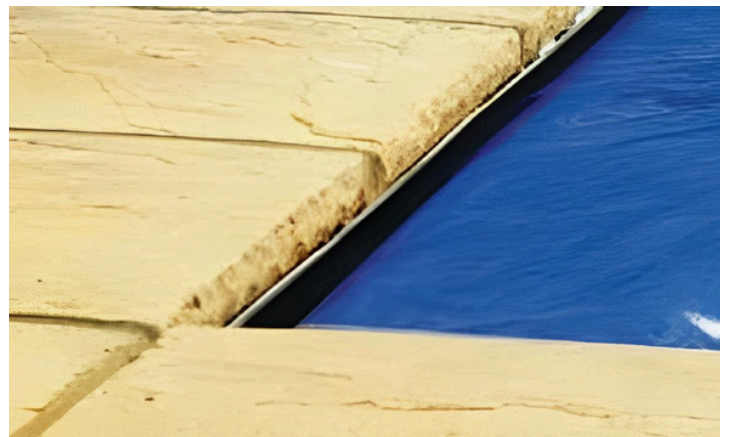

Closed - You see only the canvas

50 Years Innovation 1975-2025



& POOLlock



Proteam Europa & PoolLock

Since 1975 over 7000 swimming pools are secured with PoolLock



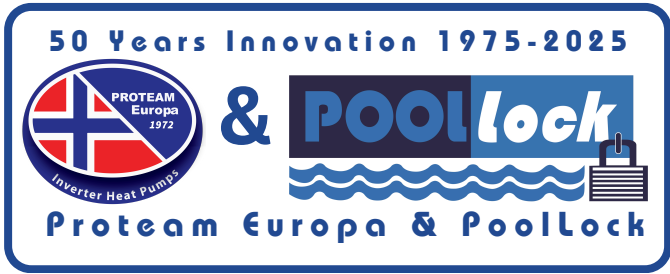

PoolLock Safety Covers

Types of Lid

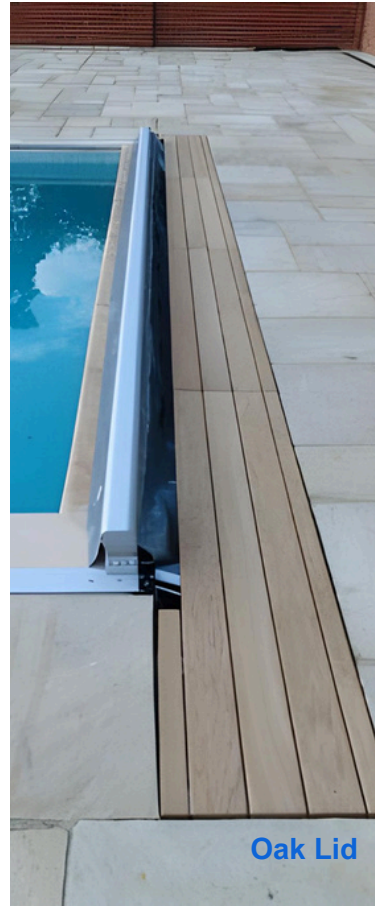

**PoolLock
Integrated Lid:
Easy removable
Tiling Tray
Hidden
Leading Bar**



PoolLock Safety Covers

Types of benches

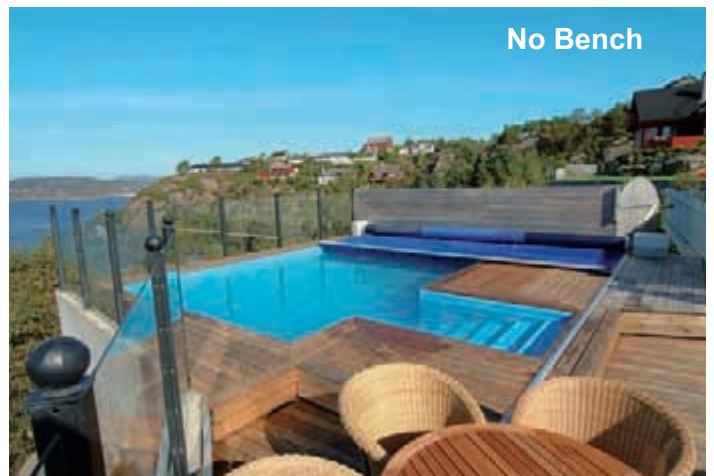
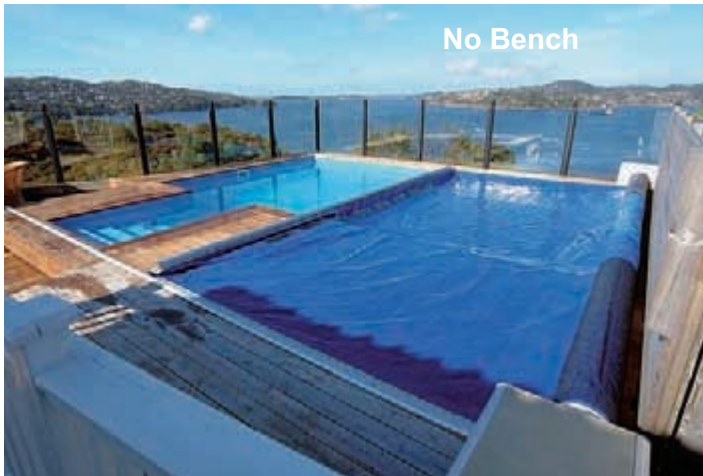



Hard Wood



Oak bench



Hard Wood



Polymer Bench

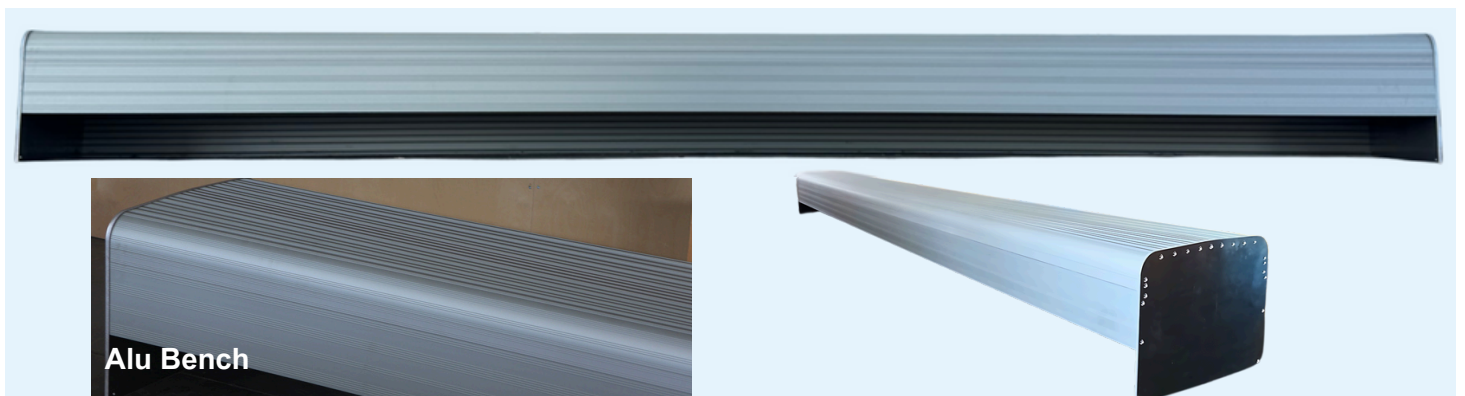

Alu Bench



PoolLock on Free-Form Pool



PoolLock on Free-Form Pool with Airnet



PoolLock V5M Manual Safety Cover SPECIAL OFFER Valid until 31 Dec. 2025

Price: TT x TL

SPECIAL OFFER: PoolLock Manual Safety Cover - Valid until 31 Dec. 2025

Proteam & PoolLock - V5M - PoolLock Manual Safety Cover

Prices are Ex Work Poollock Maidenhead UK, and PoolLock Hellas Thessaloniki

Example 8 m x 4 m Price 1,960.00 + VAT

Track to Track - TT - Pool With in CM

| CM | CM | 200 | 225 | 250 | 275 | 300 | 325 | 350 | 375 | 400 | 425 | 450 | 475 | 500 |
|---------------------------------------|-------|-------|-------|-------|-------|-------|-------|-------|-------|-------|-------|-------|-------|-------|
| Track Length - TL - Pool Length in CM | 300 | 1,180 | 1,203 | 1,225 | 1,248 | 1,270 | 1,293 | 1,315 | 1,338 | 1,360 | 1,383 | 1,405 | 1,428 | 1,450 |
| | 325 | 1,195 | 1,219 | 1,244 | 1,268 | 1,293 | 1,317 | 1,341 | 1,366 | 1,390 | 1,414 | 1,439 | 1,463 | 1,488 |
| | 350 | 1,210 | 1,236 | 1,263 | 1,289 | 1,315 | 1,341 | 1,368 | 1,394 | 1,420 | 1,446 | 1,473 | 1,499 | 1,525 |
| | 375 | 1,225 | 1,253 | 1,281 | 1,309 | 1,338 | 1,366 | 1,394 | 1,422 | 1,450 | 1,478 | 1,506 | 1,534 | 1,563 |
| | 400 | 1,240 | 1,270 | 1,300 | 1,330 | 1,360 | 1,390 | 1,420 | 1,450 | 1,480 | 1,510 | 1,540 | 1,570 | 1,600 |
| | 425 | 1,255 | 1,287 | 1,319 | 1,351 | 1,383 | 1,414 | 1,446 | 1,478 | 1,510 | 1,542 | 1,574 | 1,606 | 1,638 |
| | 450 | 1,270 | 1,304 | 1,338 | 1,371 | 1,405 | 1,439 | 1,473 | 1,506 | 1,540 | 1,574 | 1,608 | 1,641 | 1,675 |
| | 475 | 1,285 | 1,321 | 1,356 | 1,392 | 1,428 | 1,463 | 1,499 | 1,534 | 1,570 | 1,606 | 1,641 | 1,677 | 1,713 |
| | 500 | 1,300 | 1,338 | 1,375 | 1,413 | 1,450 | 1,488 | 1,525 | 1,563 | 1,600 | 1,638 | 1,675 | 1,713 | 1,750 |
| | 525 | 1,315 | 1,354 | 1,394 | 1,433 | 1,473 | 1,512 | 1,551 | 1,591 | 1,630 | 1,669 | 1,709 | 1,748 | 1,788 |
| | 550 | 1,330 | 1,371 | 1,413 | 1,454 | 1,495 | 1,536 | 1,578 | 1,619 | 1,660 | 1,701 | 1,743 | 1,784 | 1,825 |
| | 575 | 1,345 | 1,388 | 1,431 | 1,474 | 1,518 | 1,561 | 1,604 | 1,647 | 1,690 | 1,733 | 1,776 | 1,819 | 1,863 |
| | 600 | 1,360 | 1,405 | 1,450 | 1,495 | 1,540 | 1,585 | 1,630 | 1,675 | 1,720 | 1,765 | 1,810 | 1,855 | 1,900 |
| | 625 | 1,375 | 1,422 | 1,469 | 1,516 | 1,563 | 1,609 | 1,656 | 1,703 | 1,750 | 1,797 | 1,844 | 1,891 | 1,938 |
| | 650 | 1,390 | 1,439 | 1,488 | 1,536 | 1,585 | 1,634 | 1,683 | 1,731 | 1,780 | 1,829 | 1,878 | 1,926 | 1,975 |
| | 675 | 1,405 | 1,456 | 1,506 | 1,557 | 1,608 | 1,658 | 1,709 | 1,759 | 1,810 | 1,861 | 1,911 | 1,962 | 2,013 |
| | 700 | 1,420 | 1,473 | 1,525 | 1,578 | 1,630 | 1,683 | 1,735 | 1,788 | 1,840 | 1,893 | 1,945 | 1,998 | 2,050 |
| | 725 | 1,435 | 1,489 | 1,544 | 1,598 | 1,653 | 1,707 | 1,761 | 1,816 | 1,870 | 1,924 | 1,979 | 2,033 | 2,088 |
| | 750 | 1,450 | 1,506 | 1,563 | 1,619 | 1,675 | 1,731 | 1,788 | 1,844 | 1,900 | 1,956 | 2,013 | 2,069 | 2,125 |
| | 775 | 1,465 | 1,523 | 1,581 | 1,639 | 1,698 | 1,756 | 1,814 | 1,872 | 1,930 | 1,988 | 2,046 | 2,104 | 2,163 |
| | 800 | 1,480 | 1,540 | 1,600 | 1,660 | 1,720 | 1,780 | 1,840 | 1,900 | 1,960 | 2,020 | 2,080 | 2,140 | 2,200 |
| | 825 | 1,495 | 1,557 | 1,619 | 1,681 | 1,743 | 1,804 | 1,866 | 1,928 | 1,990 | 2,052 | 2,114 | 2,176 | 2,238 |
| | 850 | 1,510 | 1,574 | 1,638 | 1,701 | 1,765 | 1,829 | 1,893 | 1,956 | 2,020 | 2,084 | 2,148 | 2,211 | 2,275 |
| | 875 | 1,525 | 1,591 | 1,656 | 1,722 | 1,788 | 1,853 | 1,919 | 1,984 | 2,050 | 2,116 | 2,181 | 2,247 | 2,313 |
| 900 | 1,540 | 1,608 | 1,675 | 1,743 | 1,810 | 1,878 | 1,945 | 2,013 | 2,080 | 2,148 | 2,215 | 2,283 | 2,350 | |
| 925 | 1,555 | 1,624 | 1,694 | 1,763 | 1,833 | 1,902 | 1,971 | 2,041 | 2,110 | 2,179 | 2,249 | 2,318 | 2,388 | |
| 950 | 1,570 | 1,641 | 1,713 | 1,784 | 1,855 | 1,926 | 1,998 | 2,069 | 2,140 | 2,211 | 2,283 | 2,354 | 2,425 | |
| 975 | 1,585 | 1,658 | 1,731 | 1,804 | 1,878 | 1,951 | 2,024 | 2,097 | 2,170 | 2,243 | 2,316 | 2,389 | 2,463 | |
| 1000 | 1,600 | 1,675 | 1,750 | 1,825 | 1,900 | 1,975 | 2,050 | 2,125 | 2,200 | 2,275 | 2,350 | 2,425 | 2,500 | |
| 1025 | 1,615 | 1,692 | 1,769 | 1,846 | 1,923 | 1,999 | 2,076 | 2,153 | 2,230 | 2,307 | 2,384 | 2,461 | 2,538 | |
| 1050 | 1,630 | 1,709 | 1,788 | 1,866 | 1,945 | 2,024 | 2,103 | 2,181 | 2,260 | 2,339 | 2,418 | 2,496 | 2,575 | |
| 1075 | 1,645 | 1,726 | 1,806 | 1,887 | 1,968 | 2,048 | 2,129 | 2,209 | 2,290 | 2,371 | 2,451 | 2,532 | 2,613 | |
| 1100 | 1,660 | 1,743 | 1,825 | 1,908 | 1,990 | 2,073 | 2,155 | 2,238 | 2,320 | 2,403 | 2,485 | 2,568 | 2,650 | |
| 1125 | 1,675 | 1,759 | 1,844 | 1,928 | 2,013 | 2,097 | 2,181 | 2,266 | 2,350 | 2,434 | 2,519 | 2,603 | 2,688 | |
| 1150 | 1,690 | 1,776 | 1,863 | 1,949 | 2,035 | 2,121 | 2,208 | 2,294 | 2,380 | 2,466 | 2,553 | 2,639 | 2,725 | |
| 1175 | 1,705 | 1,793 | 1,881 | 1,969 | 2,058 | 2,146 | 2,234 | 2,322 | 2,410 | 2,498 | 2,586 | 2,674 | 2,763 | |
| 1200 | 1,720 | 1,810 | 1,900 | 1,990 | 2,080 | 2,170 | 2,260 | 2,350 | 2,440 | 2,530 | 2,620 | 2,710 | 2,800 | |

PoolLock Manual Safety Covers

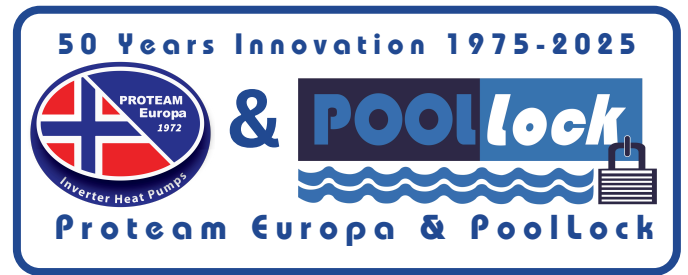

Opening: Cranking

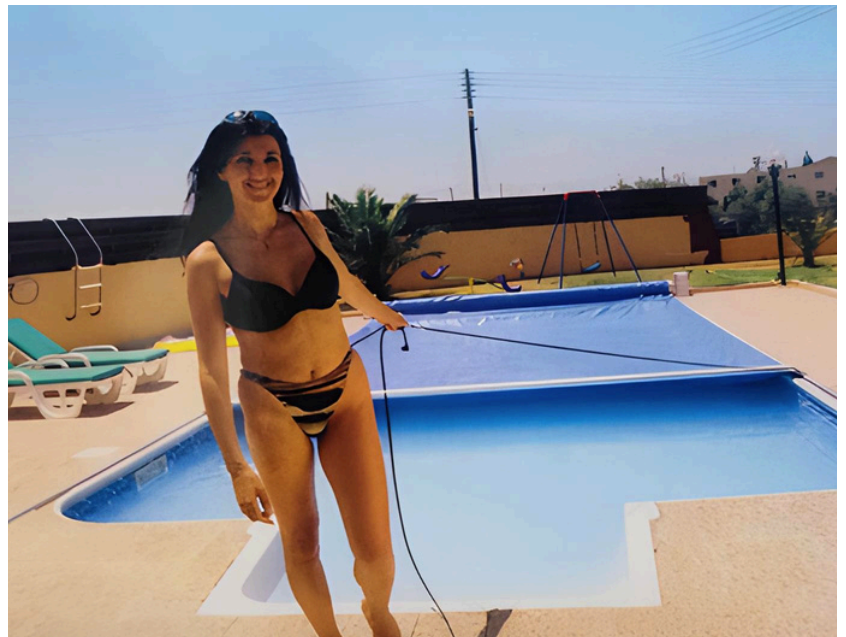

Closing: Pull the Rope

Canvas colours

No.3 Light Blue

A rectangular swatch of light blue canvas material with a visible weave pattern.

No.66 Cobalt Blue

A rectangular swatch of dark blue canvas material with a visible weave pattern.

No.2 Royal Blue

A rectangular swatch of royal blue canvas material with a visible weave pattern.

No.6 Green

A rectangular swatch of green canvas material with a visible weave pattern.

No.14 Dark Green

A rectangular swatch of dark green canvas material with a visible weave pattern.

No.7 Tan

A rectangular swatch of tan canvas material with a visible weave pattern.

Canvas colours

No.13 Transparent



No.1 White



No.11 Light Grey



No.12 Dark Grey



No.82 Charcoal



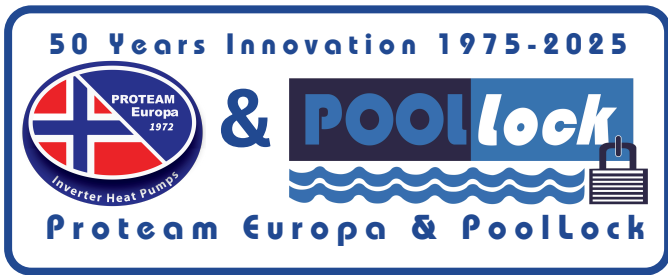

PoolDeck Slatted Covers by PoolLock



Polycarbonate

PoolDeck Slatted cover

The slats are manually sealed one by one,
and not as mostly automatically by machine.

This is one of the reasons that PoolDeck slatted covers last for many years.
PoolLock is specialist in making high quality Polycarbonate Slatted Covers.

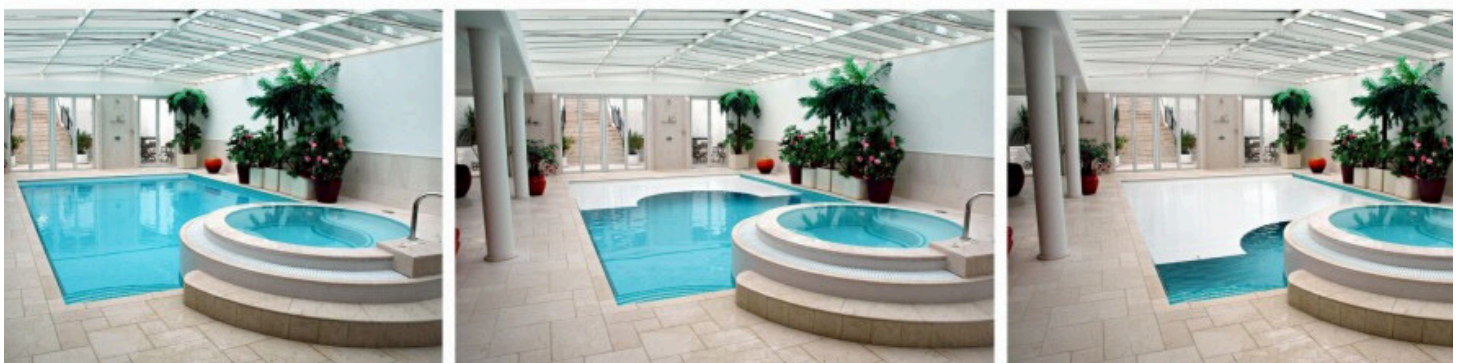

PoolDeck Slatted Cover by PoolLock

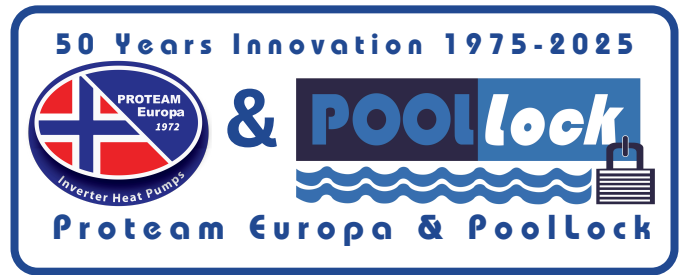

Polycarbonate



PVC Slats

PoolDeck Slatted Cover by PoolLock

50 Years Innovation 1975-2025



PROTEAM
Europa
1972
Inverter Heat Pumps

& **POOLlock**



Proteam Europa & PoolLock



PoolDeck Slatted Cover by PoolLock

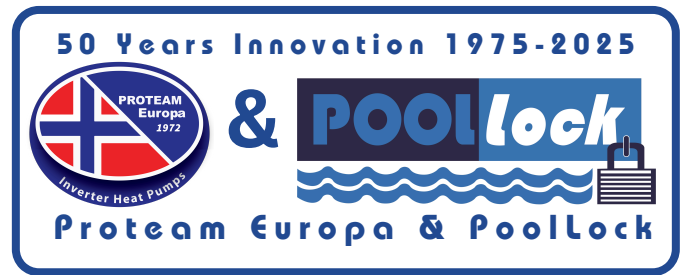

Saving... with Style

Not only will PoolLock Slatted Covers save energy, chemicals, time and money, they can also save lives!

With a few small modifications such as stainless steel handrails, specially-designed pool walls and locking systems, your PoolLock Slatted Cover can be turned into a safety cover as well*.

The low-voltage motor (24V) ensures that there is no risk of electrocution, and the switch can only be operated when the key is in the correct position.

Ask the PoolLock experts for the best solution for your pool.

* Proper adult supervision is recommended at all times



PoolDeck Slatted Cover by PoolLock

50 Years Innovation 1975-2025



PROTEAM Europe 1972
Inverter Heat Pumps

& **POOLlock**



Proteam Europa & Poollock



Our slatted covers are not only elegant and stylish, but they will save you money as well.

A PoolLock slatted cover will significantly reduce the amount of heat loss through evaporation.

This means that you need less energy to heat your pool and the consumption of chemicals will also be reduced.

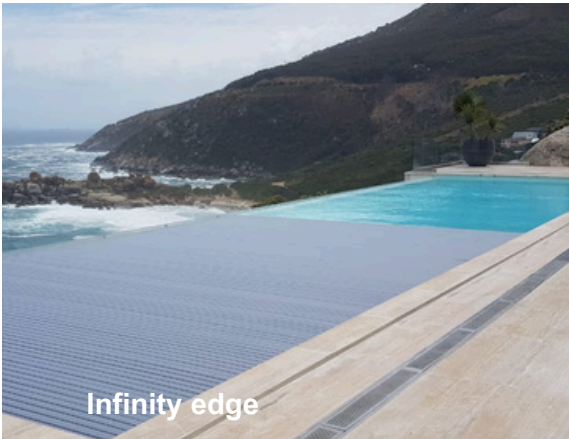

under water installation*

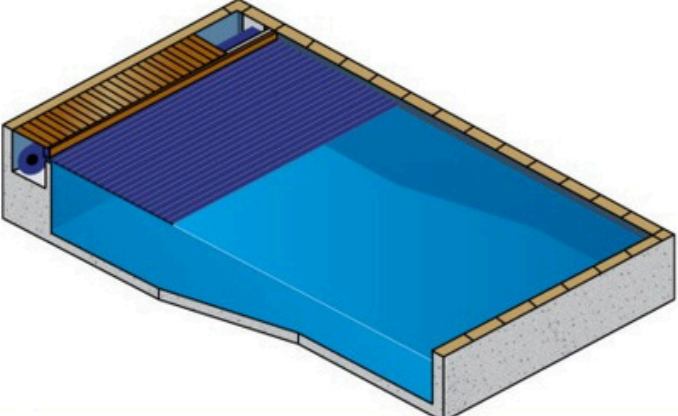
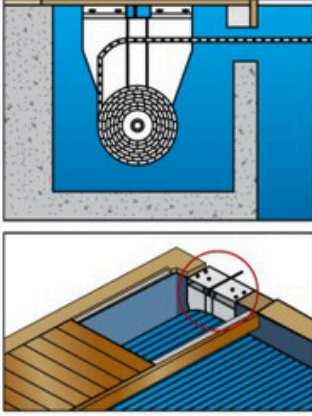
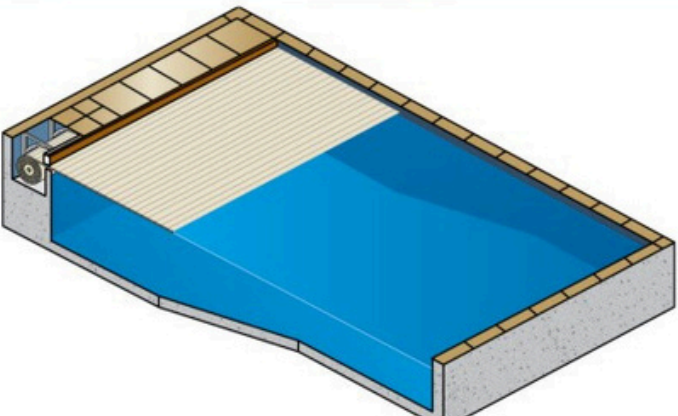
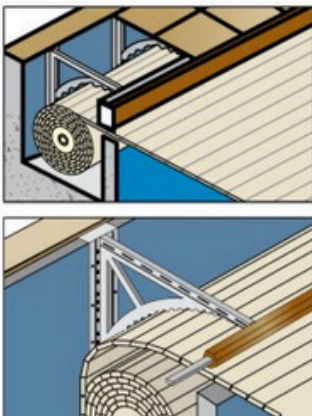
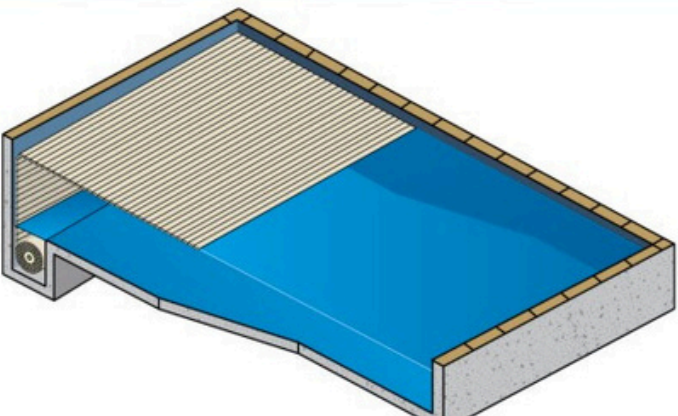
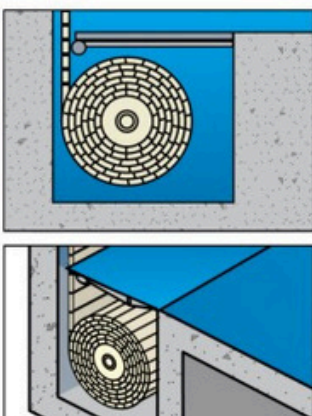
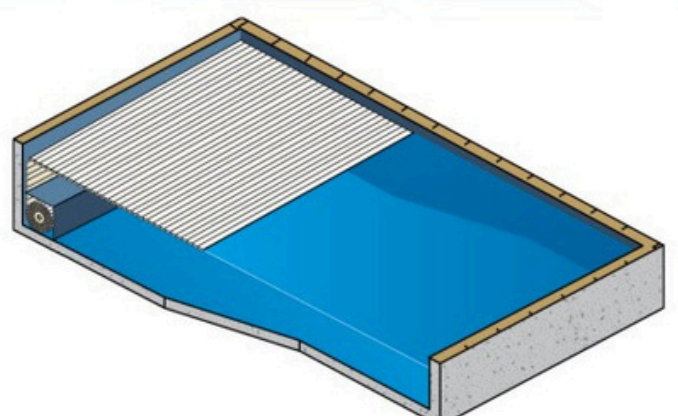
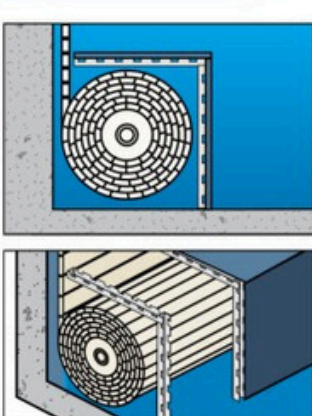
| | | | |
|--------------------------|---|--|--|
| Under Water Installation |  |  | Wet Pit Installation with Wooden Lid |
| Under Water Installation |  |  | Wet Pit Installation with Tiling Trays |
| Under Water Installation |  |  | Bottom Pit Installation |
| Under Water Installation |  |  | Bottom Box Installation |

*Drawings for illustrative purposes only - actual designs may vary according to updated systems

**Bottom
Installation**

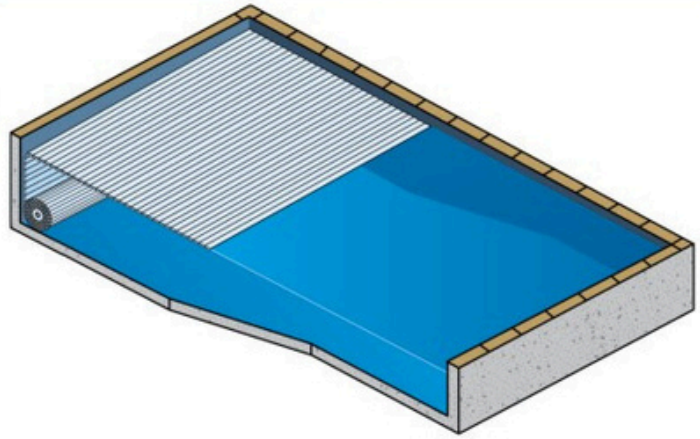
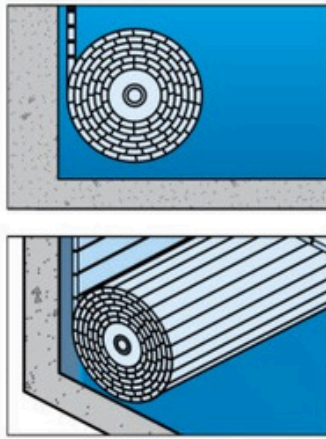

Under Water Installation

**In-Wall
(Cave) Pit
Installation**

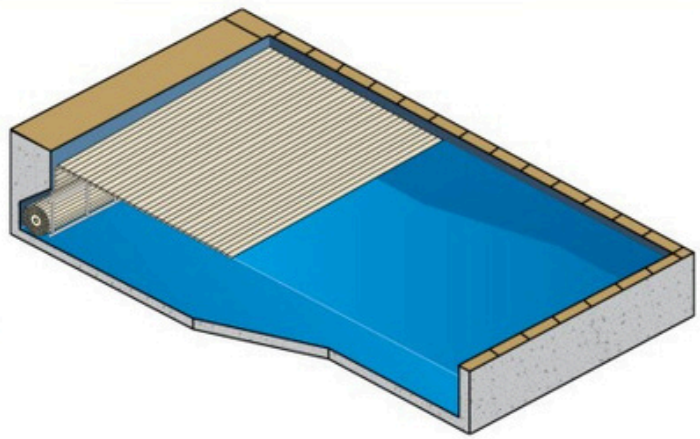
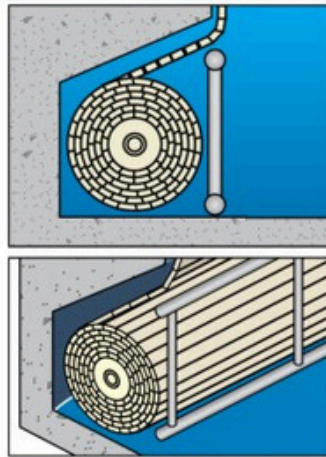

Under Water Installation

top mount installation*

**Without
Bench**

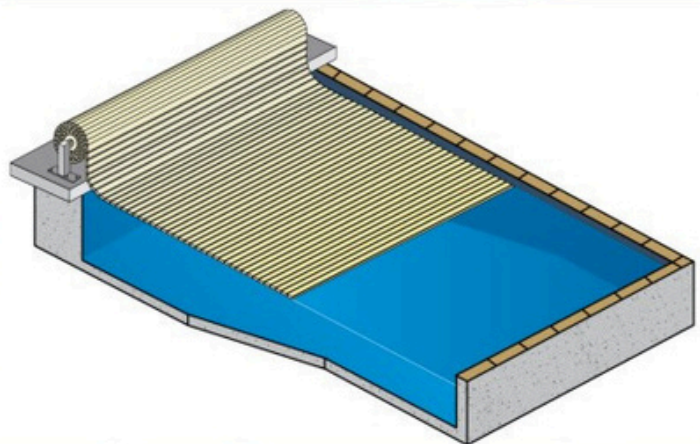
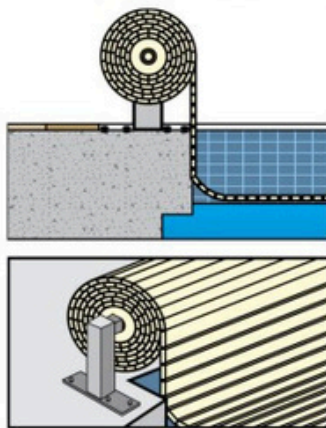

Top Mounted Installation

**With
Wooden
Bench**

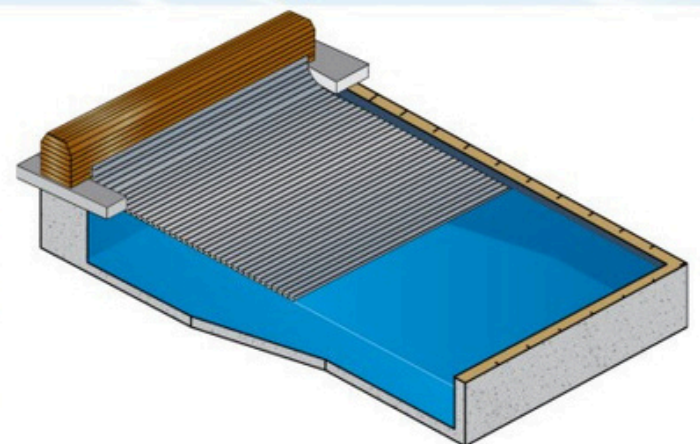
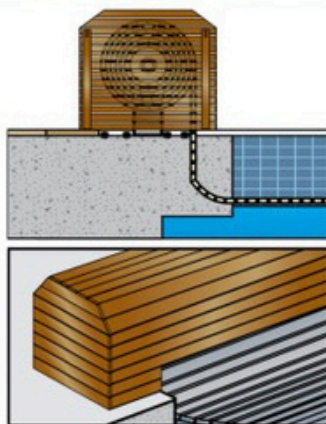

Top Mounted Installation

*Drawings for illustrative purposes only - actual designs may vary according to updated systems



slatted covers colours*



PVC
White



Polycarbonate
White



PVC
Light Blue



Polycarbonate
Light Blue



PVC
**Clear Blue
(solar)**



Polycarbonate
**Clear Blue
(solar)**



PVC
**Grey



Polycarbonate
Crystal Clear



PVC
**Dark Blue
(solar)**

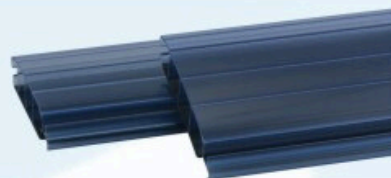

*Other colours available upon request

**not standard

PoolLock Slatted Cover

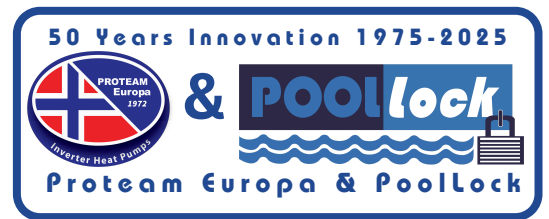

Types of installation

PoolLock Slatted Covers can be installed in a number of different ways to suit your needs. Underwater installations ensure that the roller and motor remain out of sight: when the pool is open, you will not even know you have a cover! There are several types of underwater installations available. These will depend on the characteristics of the pool. We would be happy to advise you on which options are best for you.

For existing pools, where it is not possible or practical to carry out construction work, PoolLock Slatted Covers can either be installed at the bottom of your pool or, more easily, on the deck around your pool. This type of installation is extremely simple and requires minimal preparation work. Rollers can be covered by benches to match with your pool surroundings.

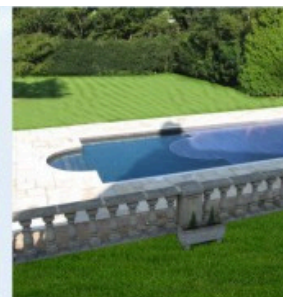
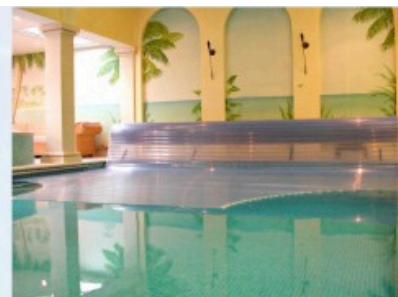
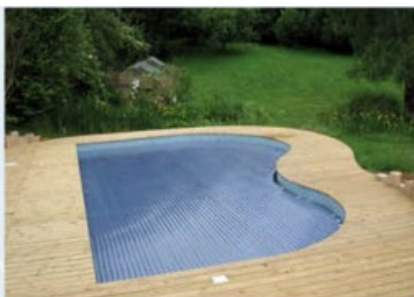

Polycarbonate
Dark Blue
(Solar)

PoolLock Slatted Cover Infinity - Installed in 2009

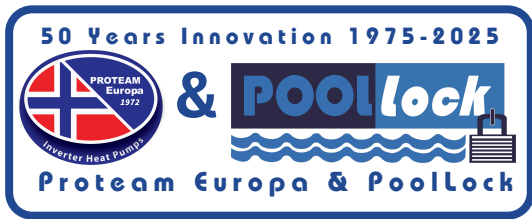

PROTEAM Pool Heat Pumps

PS Silent models



PROTEAM Swimming pool inverter Heat Pumps PS, with the lowest noise on the market

PROTEAM Silent



Technical Data

| Model | | PS15 | PS20 | PS25 | PS35 |
|--|---------|--------------|--------------|--------------|--------------|
| Performance Condition: Air 27°C, Water 26°C, Humidity 80% | | | | | |
| Heating capacity (min-max) | KW | 3.15-14.00 | 4.00-20.00 | 4.80-24.00 | 6.50-32.50 |
| Power input (min-max) | KW | 0.21-2.15 | 0.27-3.33 | 0.32-4.00 | 0.43-5.42 |
| COP | W/W | 6.50-15.00 | 6.00-14.80 | 6.00-15.00 | 6.00-15.00 |
| Performance Condition: Air 15°C, Water 26°C, Humidity 70% | | | | | |
| Heating capacity (min-max) | KW | 2.40-10.70 | 2.85-15.60 | 3.42-18.70 | 5.07-25.40 |
| Power input (min-max) | KW | 0.34-2.12 | 0.40-3.25 | 0.49-3.89 | 0.72-5.29 |
| COP | W/W | 5.00-7.10 | 4.80-7.00 | 4.80-7.00 | 4.80-7.00 |
| Performance Condition: Air 35°C, Water 28°C, Humidity 80% | | | | | |
| Cooling capacity | KW | 7.2 | 10.1 | 11.8 | 15.6 |
| Power supply | V/Ph/Hz | 220-240/1/50 | 220-240/1/50 | 220-240/1/50 | 220-240/1/50 |
| Noise level - Distance <1m | db(A) | 42-51 | 43-53 | 44-54 | 45-57 |
| Compressor | | Panasonic | Panasonic | Panasonic | Panasonic |
| Refrigerant | | R32 | R32 | R32 | R32 |
| Casing Material | | Metal casing | Metal casing | Metal casing | Metal casing |
| Net dimensions (mm) (L x W x H) | | 980*402*636 | 1107*503*760 | 1107*503*760 | 1187*503*900 |

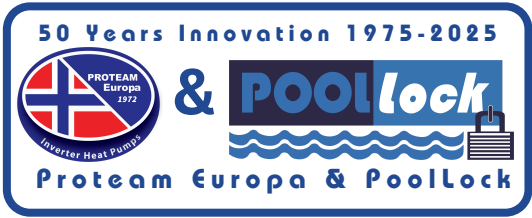

PROTEAM Pool Heat Pumps

Proteam Silent models (PS)



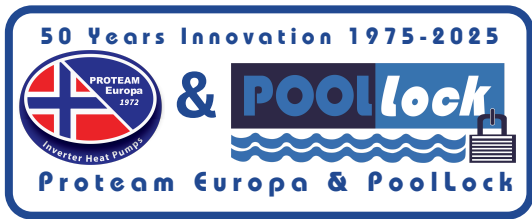

PROTEAM House Heat Pump PRO models



Technical Data

| Model | | PRO 15i | PRO 20i | PRO 25i | PRO 30i |
|-------------------------------|---------|-------------------|--------------------|--------------------|--------------------|
| Heating at A7/W35 | | | | | |
| Heating capacity (min-max) | KW | 8.30 (3.65-10.38) | 11.60 (5.10-14.50) | 12.00 (5.28-15.00) | 16.30 (8.80-21.20) |
| Power input (min-max) | KW | 1.93 (0.85-2.42) | 2.75 (1.21-3.44) | 2.90 (1.28-3.63) | 3.69 (1.99-4.80) |
| COP | W/W | 4.30 (3.01-5.16) | 4.22 (3.03-5.10) | 4.15 (3.0-5.0) | 4.42 (3.10-5.30) |
| Heating at A2/W55 | | | | | |
| Heating capacity (min-max) | KW | 6.72 (2.96-8.10) | 9.61 (4.23-12.00) | 9.70 (4.59-12.63) | 13.81 (7.45-17.95) |
| Power input (min-max) | KW | 2.71 (1.20-3.39) | 3.74 (1.65-4.68) | 3.99 (1.76-4.84) | 4.93 (2.66-6.41) |
| COP | W/W | 2.48 (2.0-3.60) | 2.57 (2.20-3.70) | 2.43 (2.00-3.60) | 2.80 (2.20-3.90) |
| Cooling at A35/W7 | | | | | |
| Cooling capacity (min-max) | KW | 6.20 (3.40-8.10) | 9.30 (5.15-12.09) | 9.50 (5.22-12.35) | 13.30 (7.10-17.30) |
| Power input (min-max) | KW | 2.20 (1.21-2.86) | 3.25 (1.76-4.16) | 3.28 (1.79-4.20) | 4.60 (2.53-5.98) |
| EER | W/W | 2.80 (2.00-3.42) | 2.85 (2.05-3.42) | 2.80 (2.00-3.50) | 2.90 (2.10-3.48) |
| Noise level - Distance <1m | dB(A) | 63 | 67 | 67 | 73 |
| Power supply | V/Ph/Hz | 220-240/1/50 | 220-240/1/50 | 380-415/3N/50 | 380-415/3N/50 |
| Refrigerant | | R290(1100g) | R290(1200g) | R290(1200g) | R290(1600g) |
| Operating outdoor temperature | °C | -25~43 | -25~43 | -25~43 | -25~43 |
| Max water temperature | °C | 75 | 75 | 75 | 75 |
| Min water temperature | °C | 10 | 10 | 10 | 10 |



R290 Heat Pumps - the Future

by Harald Einevoll

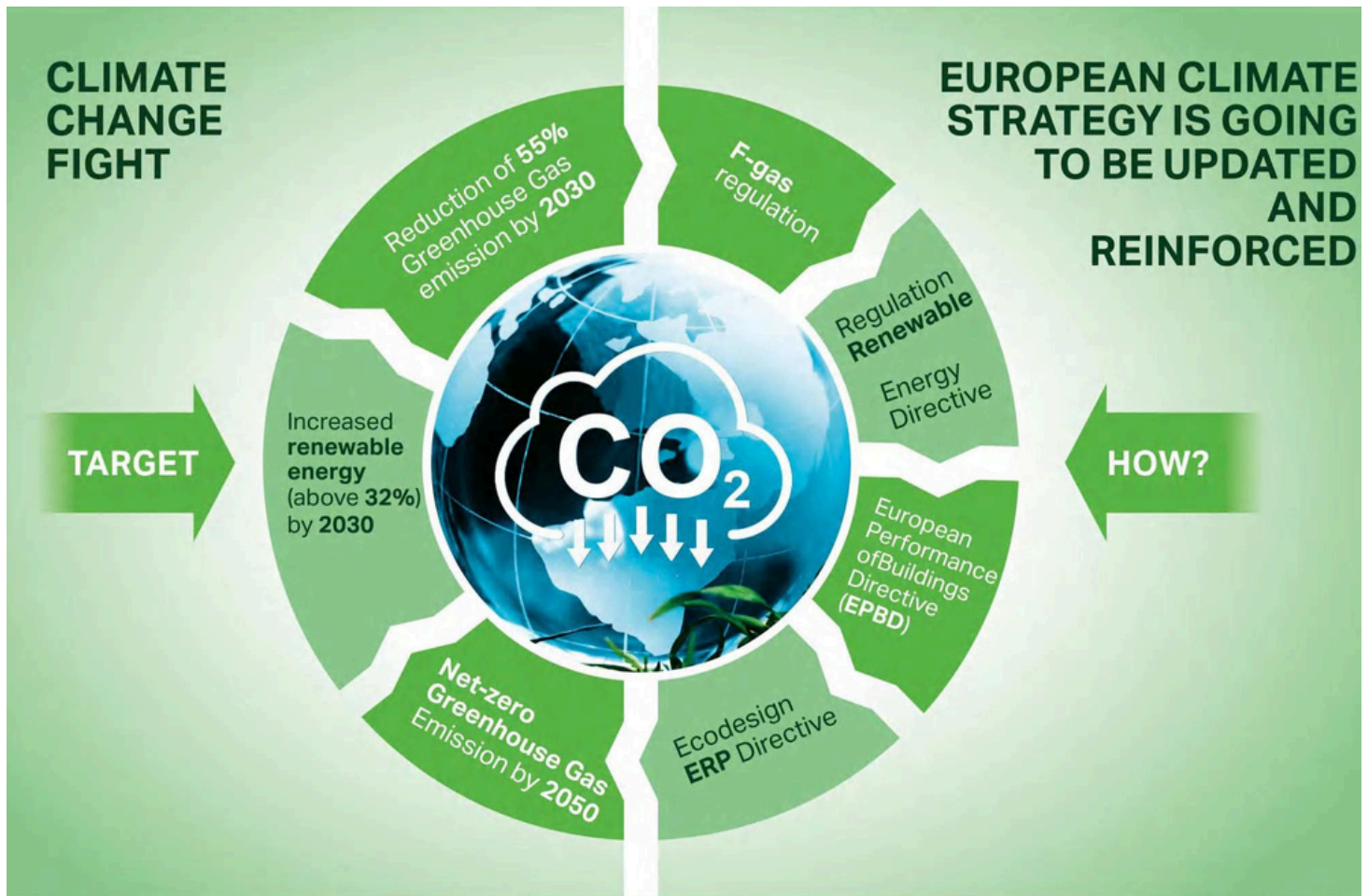

Good to know about Refrigerant Gas:

- In 1972 R12 and R22 were the most used refrigerants. Now these refrigerants are not allowed at all.
- R410 was used from the year 2000. - Low temperature range, pressure up to 40 Bar. (Low-cost Gas)
- Many manufacturers are now using R32. - Better temperature range than R410A, but much higher pressure (50 Bar) (Low-cost Gas).
- R290 - The refrigerant of the future. Only the higher cost has held R290 back to be used.
- R290 has high temperature range. Lower pressure. Higher efficacy, but R290 is more expensive.

PROTEAM's future Heat Pumps, Pool and House will have R290 refrigerant

R290 (Propane) – Almost Zero Environmental effect.

R290 Safety Group 3. (This class has a danger risk).

Siv. Ing Harald Einevoll considers the fire/explosion risk very low.

a. The self-ignition temperature is 470 °C. (Very low chance of self-ignition)

b. Gravity weight: 1.86 kg/m³ (Air 1.2 kg/m³). (Heavier than air)

c. Since R290 is heavier than air it will stay low and go to any potential drainage.

d. Health risk? - Because of its high gravity weight, R290 has a low health risk in case of leakages.



PROTEAM House Heat Pumps R290 Performance

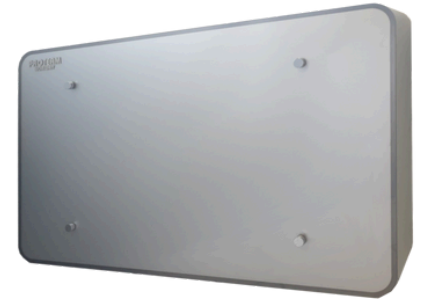
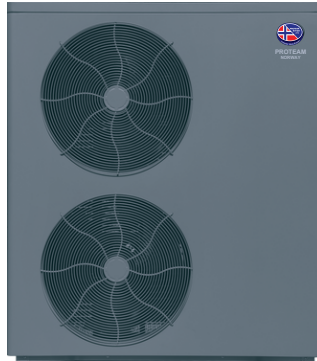

R290 Performance

- Low working pressure means lower electrical consumption and less wearing.
- In temperature minus 30 °C (1.67 bar) to plus 75 °C (28.6 bar).
- With our new DC Performance Inverter, we gain 5% to 20% efficiency.
- On PROTEAM's new Heat Pump the performance is increased by around 30%.
- The higher performance is most noticeable on Air Temperatures lower than 15 °C.

Warranty

PROTEAM's Heat Pump with R290 has 5 Years Warranty:

Our testing over the last 2 years shows that the failure risk is very low.
(Norwegian Quality Testing Procedure in our factory)

- We give a 5-year warranty on all components worldwide.
- PROTEAM will provide free components from the nearest representative.
- In some countries we offer 1 year full exchange guarantee if the failure requires opening of the refrigerant system.
- PROTEAM will offer a new Heat Pump for free from any of PROTEAM's depo.



New DC Slope Inverter for
PROTEAM Heat Pumps with R290

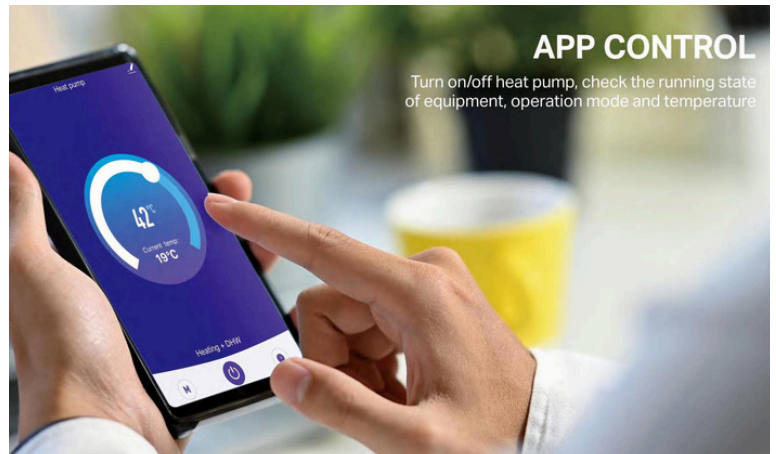

APP CONTROL

Turn on/off heat pump, check the running state of equipment, operation mode and temperature



Roof



FS 400 🔥 2.40 KW ❄️ 1.81 KW
FS 800 🔥 4.23 KW ❄️ 3.38 KW



Wall (High Wall)



HW 600 🔥 2.45 KW ❄️ 1.70 KW
HW 800 🔥 3.30 KW ❄️ 2.45 KW



Floor



FS 400 🔥 2.40 KW ❄️ 1.81 KW
FS 800 🔥 4.23 KW ❄️ 3.38 KW



Bath



BT 400 🔥 1.45 KW ❄️ 1.20 KW

PROTEAM

NORWAY

Silent Fancoils

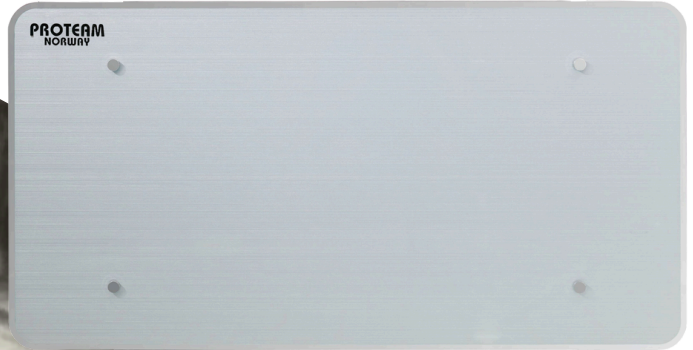

**PROTEAM
NORWAY**

Low, Low noise

**PROTEAM Silent
20dB(A)**



Technical Data

| Model | | | HW 600 | HW 800 | FS 400 | FS 800 | BT 400 |
|----------------------|---------|-------------------|---------------------------|-----------|-----------|-----------|-----------|
| Cooling capacity | 7-12°C | KW | 1.70 | 2.45 | 1.81 | 3.38 | 1.20 |
| Heating capacity | 50°C | KW | 2.45 | 3.30 | 2.40 | 4.23 | 1.45 |
| Heating capacity | 70-50°C | KW | 2.59 | 4.22 | 4.42 | 4.20 | 2.09 |
| Max air flow | | m ³ /h | 450 | 540 | 305 | 520 | 225 |
| Med air flow | | m ³ /h | 350 | 430 | 220 | 430 | 175 |
| Min air flow | | m ³ /h | 240 | 310 | 150 | 300 | 120 |
| Electric input power | | W | 5-14 | 8-17 | 4-11 | 8-17 | 4-11 |
| Sound level | | db(A) | 23.4-38.3 | 25.0-39.1 | 21.6-35.2 | 21.7-36.3 | 19.1-34.0 |
| Motor type | | | DC Inverter | | | | |
| Fan | | | Aluminum cross fan | | | | |
| Filter | | | Stainless steel microwave | | | | |
| Front panel | | | Tempered crystal | | | | |



The children who once enjoyed it are now around 40 years old



+44 1293 77 44 14
www.poollockuk.com
factory@poollockuk.com

www.poollockuk.com

+30 2310 462 122
www.poollockgr.com
factory@poollockgr.com



www.poollockgr.com

Proteam and PoolLock production

